

Fisher-Price®

**74306
Instructions**

Special Edition Townhouse

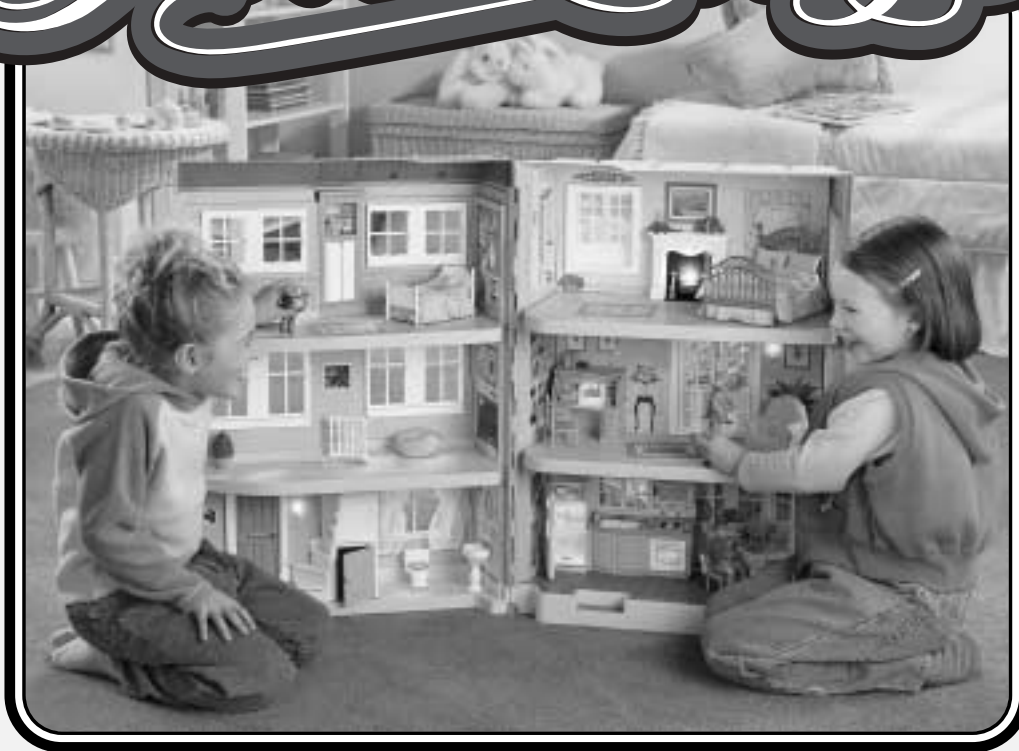

Please keep this instruction sheet for future reference, as it contains important information.

Adult assembly is required.

Requires three "D" (LR20) alkaline batteries (not included).

Tool required for assembly: Phillips screwdriver (not included).



www.fisher-price.com

Assembled Parts

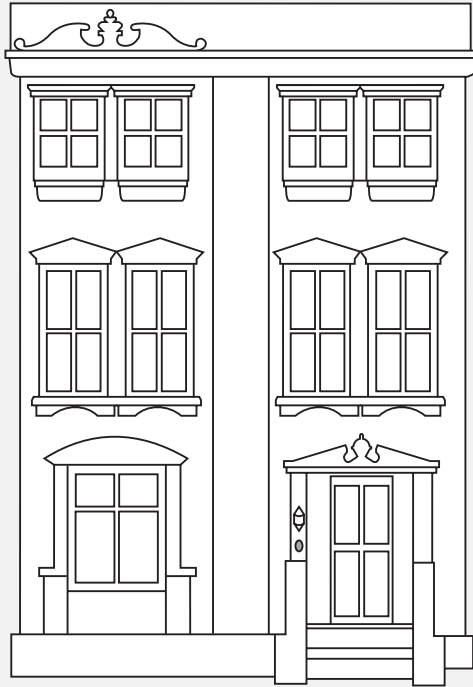

Townhouse

Other Parts Included (not shown)

Father

Mother (with Shirt)

Daughter (with Vest)

Hint: Clothing is removable on mother and daughter figure.

Arm chair (with Fabric Slipcover and Pillow)

Rocking Chair

Beanbag Chair

Adult Bed with Soft Bedding (2 Pillows, Dust Ruffle and Bed Spread)

Hint: Dust ruffle is designed to fit tightly on the bed.

Child's Bed with Soft Bedding (Pillow, Dust Ruffle and Bed Spread)

Kitchen Table with 2 Chairs

Potted Plant

Floor Lamp

3 Throw Rugs

Desk Chair

Adirondack Chair

Label Sheet



#8 x 3/4" Screw - 2

Shown Actual Size

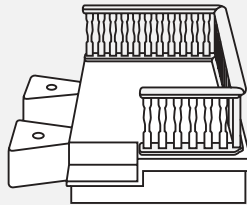

Deck



4 Window Box Flowers



3 Window Films

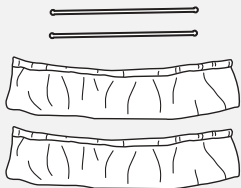

2 Valances
with 2 Valance rods (Longer)

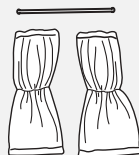

2 Curtains
with Curtain Rod (Shorter)

Battery Installation

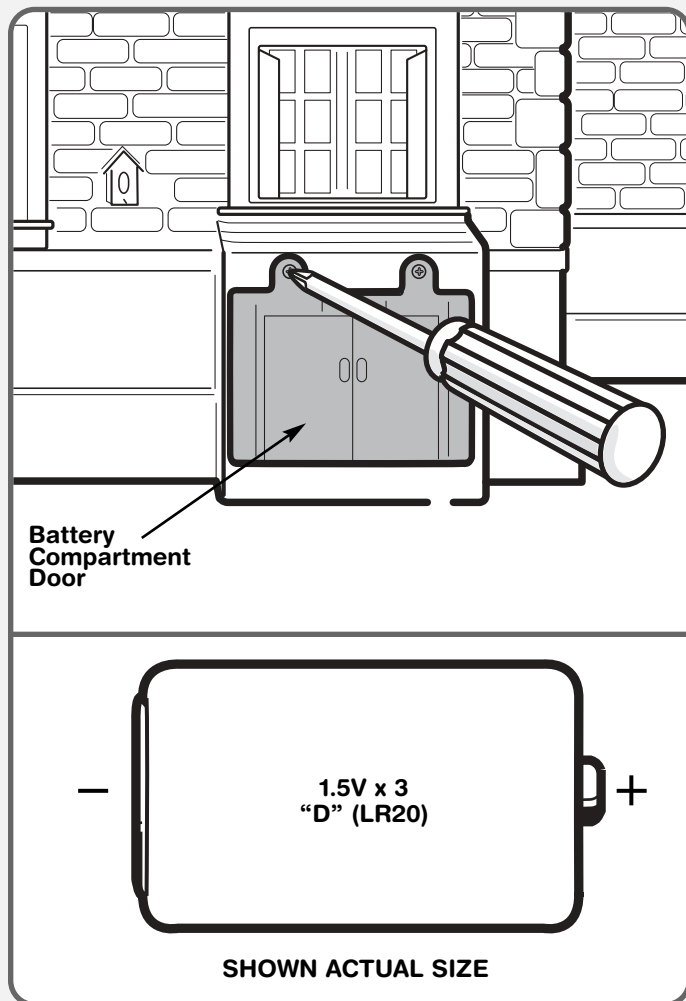

- Locate the battery compartment on the back of the Townhouse.
 - Loosen the screws in the battery compartment door with a Phillips screwdriver.
 - Lift to remove the battery compartment door.
 - Insert three "D" (LR20) **alkaline** batteries.
- Helpful Hint:** We recommend using **alkaline** batteries for longer battery life.
- Replace the battery compartment door and tighten the screws with a Phillips screwdriver. Do not over-tighten.
 - When sounds or lights from this toy stop working, stay on constantly, or work erratically, it's time for an adult to replace the batteries!

Battery Safety Information

Batteries may leak fluids that can cause a chemical burn injury or ruin your product. To avoid battery leakage:

- Do not mix old and new batteries or batteries of different types: alkaline, standard (carbon-zinc) or rechargeable (nickel-cadmium).
- Insert batteries as indicated inside the battery compartment.
- Remove batteries during long periods of non-use. Always remove exhausted batteries from the product. Dispose of batteries safely. Do not dispose of batteries in a fire. The batteries may explode or leak.
- Never short-circuit the battery terminals.
- Use only batteries of the same or equivalent type, as recommended.
- Do not charge non-rechargeable batteries.
- Remove rechargeable batteries from the product before charging.
- If removable, rechargeable batteries are used, they are only to be charged under adult supervision.

Attaching the Deck

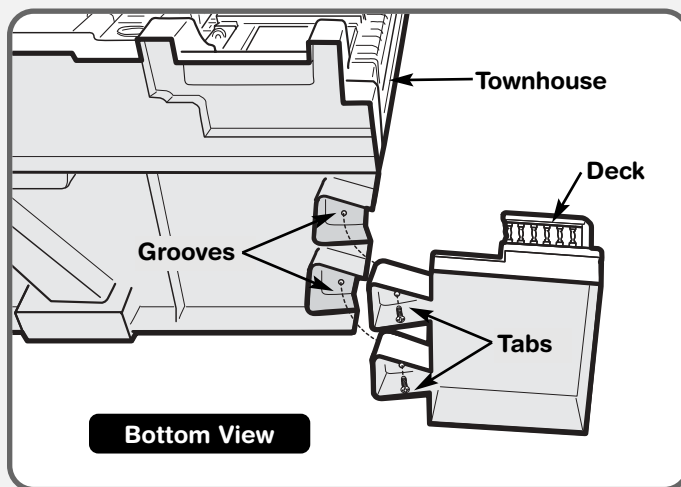

- Position the Townhouse face up on a flat surface, so that the bottom faces you.
- Fit the deck tabs into the grooves in the bottom of the Townhouse, as shown.
- Insert two screws through the holes in the bottom of the deck and into the bottom of the Townhouse.
- Tighten the screws with a Phillips screwdriver. Do not over-tighten.

Let's Decorate!

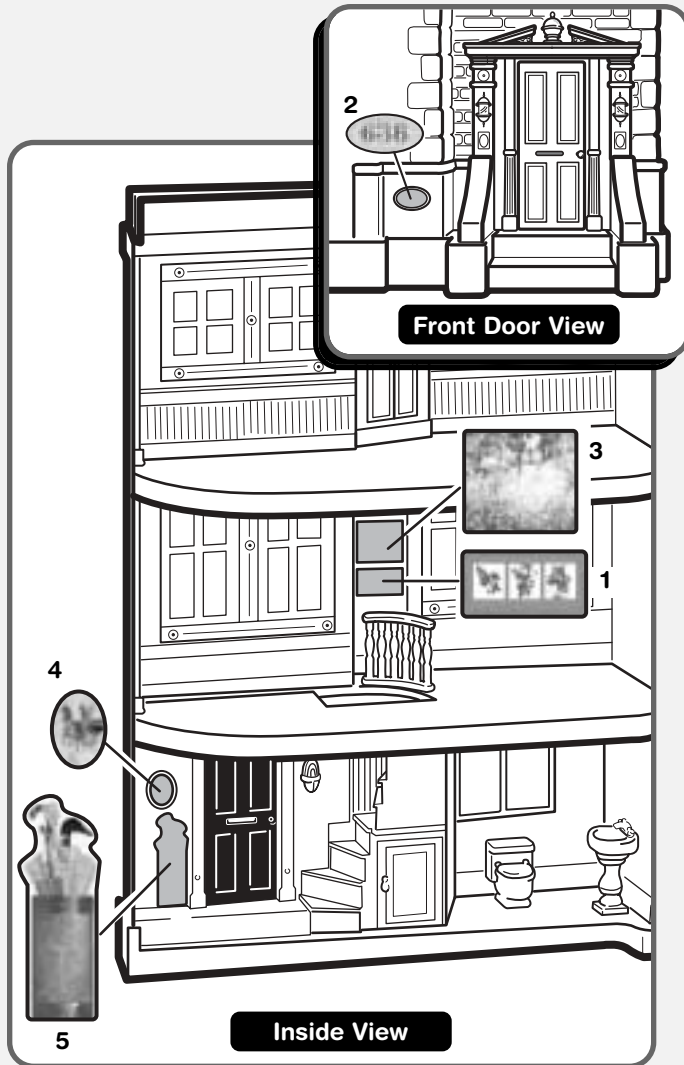

Helpful Hint: Apply the labels as shown in the illustrations. For best results, wash your hands before applying the labels and make sure the areas to which the labels will be applied are clean and dry.

- Apply the top corners of a label first and smooth downward to remove any air bubbles.
- For best results, avoid repositioning a label once it has been applied.

Inserting the Window Films

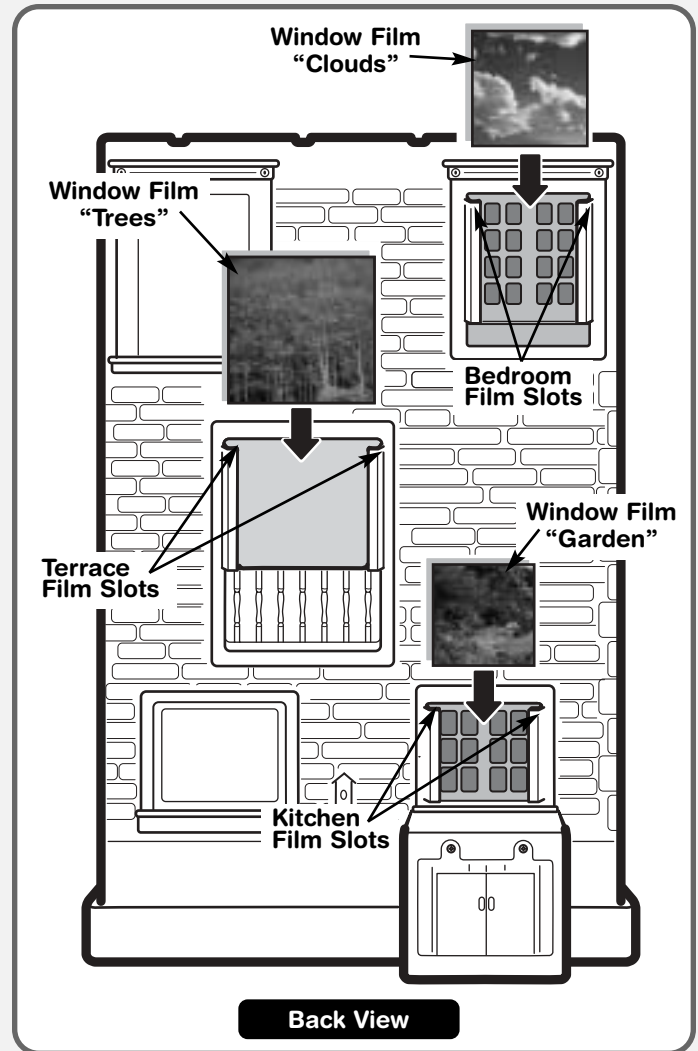

Helpful Hint: The window films "illuminate" when light is behind the Townhouse. For best results, place the Townhouse in front of a window or other light source.

- Locate the film slots on the back of the Townhouse.
- Insert and slide the "cloud" film into the bedroom film slots.
- Insert and slide the "trees" film into the terrace film slots.
- Insert and slide the "garden" film into the kitchen film slots.

Adding the Flowers

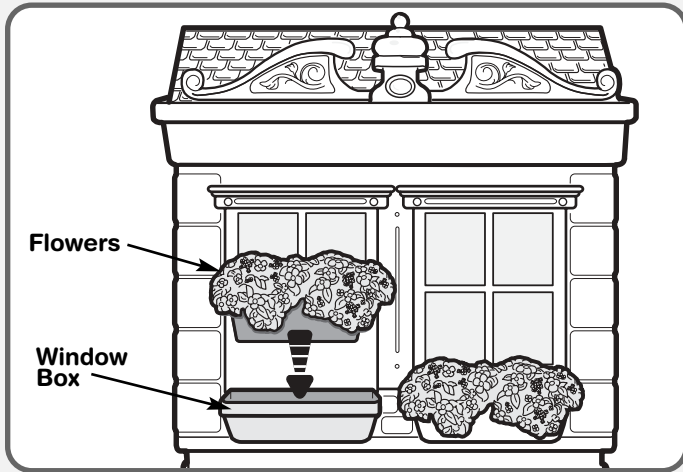

Helpful Hint: The flowers can be attached and re-attached to any window box.

- Locate the window boxes on the outside of the Townhouse.
- Fit the tab on a flower onto the edge of a window box.

Attaching the Curtains and Valances

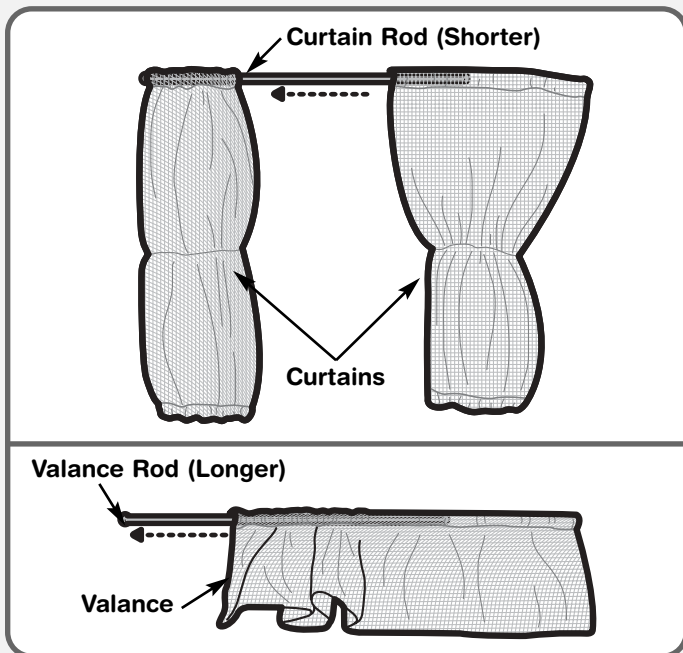

Helpful Hint: Use the longer curtain rods for double windows and the shorter curtain rod for the single window.

- Slide a curtain or valance on to a curtain rod, as shown.

Let's Hang the Curtains

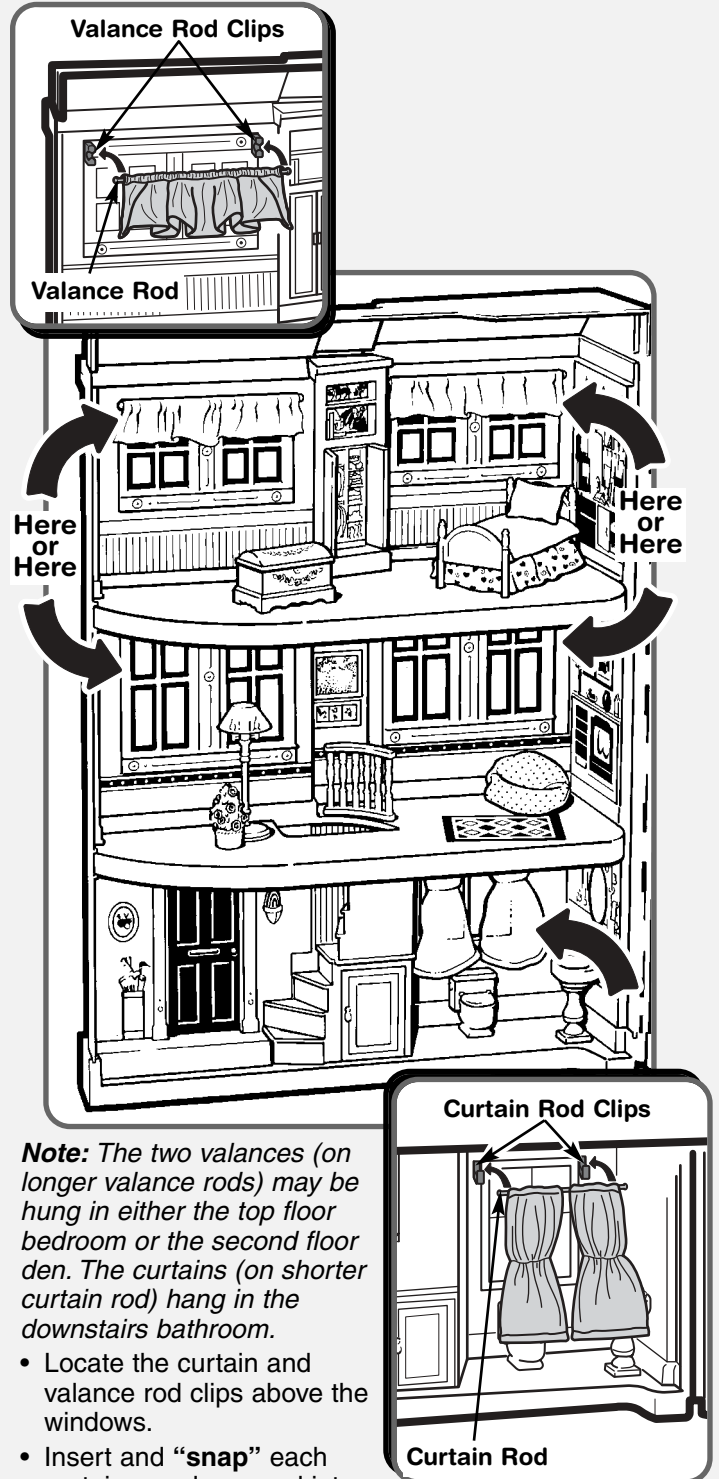

Note: The two valances (on longer valance rods) may be hung in either the top floor bedroom or the second floor den. The curtains (on shorter curtain rod) hang in the downstairs bathroom.

- Locate the curtain and valance rod clips above the windows.
- Insert and “snap” each curtain or valance rod into each set of clips as shown.

Let's Play!



- Rotate the Townhouse walls out to open.

Ding Dong

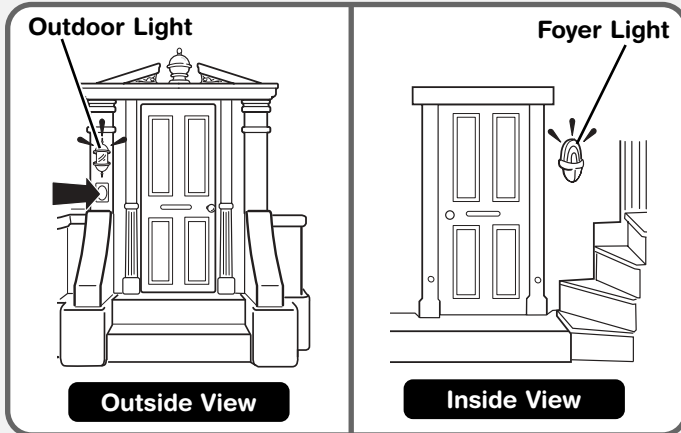

- Press the door bell to hear it ring and turn on the front door light and inside foyer light.

Fun Lights and Sounds!

Hint: All lights will turn off automatically after up to three minutes.

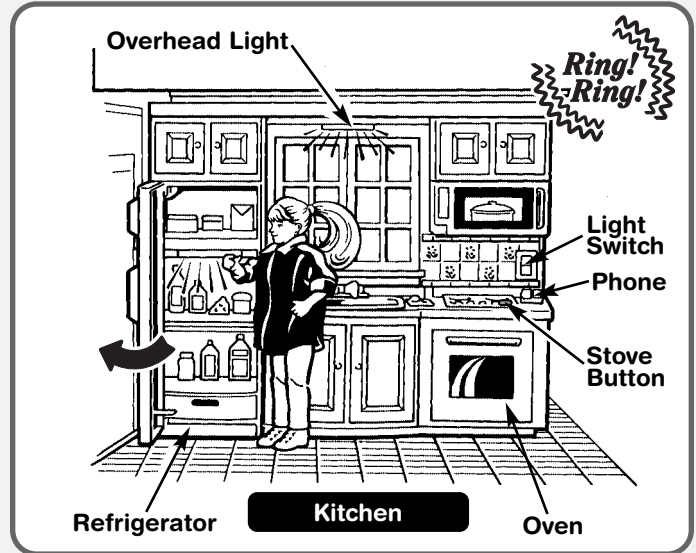

- Press the phone to hear it ring.
- Press the light switch to turn on the overhead light.
- Open the refrigerator to turn on its interior light.
- Press the stove button to turn on the stove burners and the oven light.

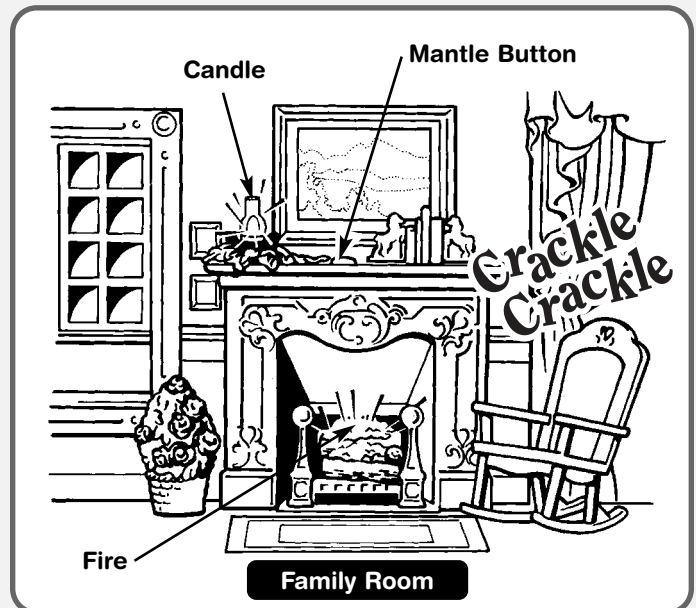

- Press the mantle button to light the fire and the candle.

Lights and Sounds, Please!

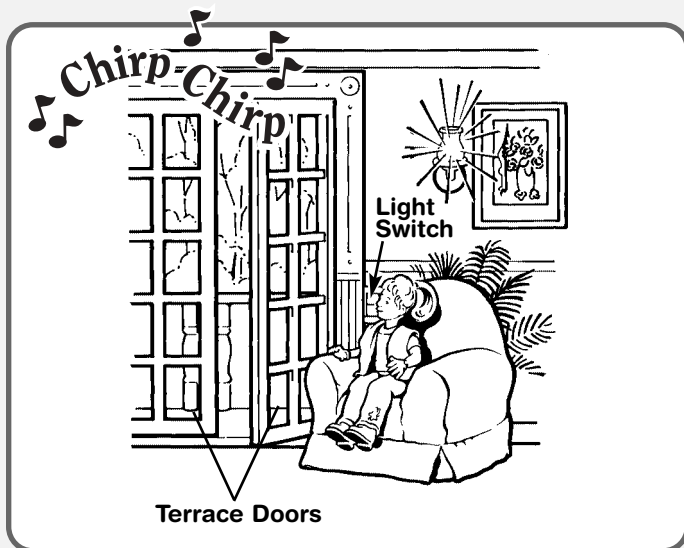

- Open the terrace doors to hear birds chirping.
- Press the light switch to turn on the light.

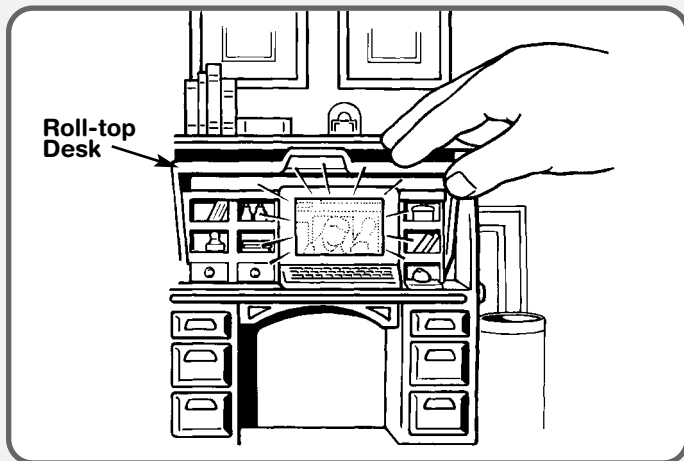

- Open the roll-top desk and the computer screen glows!

Playtime's Over

- Place the family and their accessories inside the Townhouse.
- Rotate the front side of the Townhouse toward the backside until they almost meet.

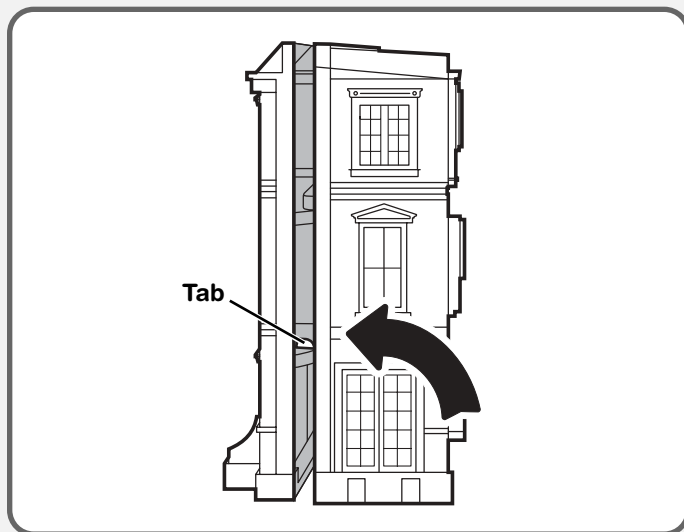

- Lift the back (wider) side slightly and close it over the tab on the front (narrower) side.

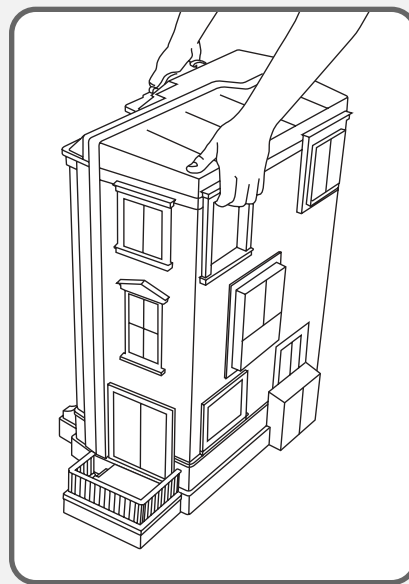

- After the Townhouse is latched closed, the product can be carried by an adult. Grasp the Townhouse in the upper left windows as shown.

FCC Statement (United States Only)

Note: This equipment has been tested and found to comply with the limits for a Class B digital device, pursuant to Part 15 of the FCC Rules. These limits are designed to provide reasonable protection against harmful interference in a residential installation. This equipment generates, uses and can radiate radio frequency energy and, if not installed and used in accordance with the instructions, may cause harmful interference to radio communications. However, there is no guarantee that interference will not occur in a particular installation. If this equipment does cause harmful interference to radio or television reception, which can be determined by turning the equipment off and on, the user is encouraged to try to correct the interference by one or more of the following measures:

- Reorient or relocate the receiving antenna.
- Increase the separation between the equipment and receiver.
- Connect the equipment into an outlet on a circuit different from that to which the receiver is connected.
- Consult the dealer or an experienced radio/TV technician for help.

Note: Changes or modifications not expressly approved by the manufacturer responsible for compliance could void the user's authority to operate the equipment.

Consumer Information

Questions? We'd like to hear from you!

Call Fisher-Price® Consumer Relations, toll-free at **1-800-432-5437**, 8 AM - 6 PM EST Monday through Friday. Hearing-impaired consumers using TTY/TDD equipment, please call 1-800-382-7470.

Or, write to:

Fisher-Price® Consumer Relations
636 Girard Avenue
East Aurora, New York 14052, U.S.A.

For countries outside the United States:

CANADA: Questions? 1-800-567-7724, Mattel Canada Inc., 6155 Freemont Blvd., Mississauga, Ontario L5R 3W2.

GREAT BRITAIN: Mattel UK Ltd, Vanwall Business Park, Maidenhead SL6 4UB. Helpline: 01628 500302.

AUSTRALIA: Mattel Australia Pty. Ltd., 658 Church Street, Locked Bag #870, Richmond, Victoria 3121 Australia. Consumer Advisory Service 1300 135 312.

NEW ZEALAND: 16-18 William Pickering Drive, Albany 1331, Auckland.

ASIA: Mattel East Asia Ltd, Room 1106, South Tower, World Finance Centre, Harbour City, Tsimshatsui, HK, China.